

TFT LCD TV

HYUNDAI

<English>
32" TFT LCD TV

OWNER'S MANUAL

HLT-3272

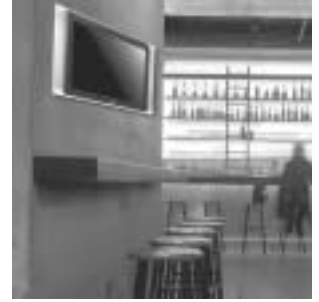

English

OWNER'S MANUAL

Please read this manual carefully before operating your set.

Retain it for future reference.

Record model number and serial number of the set.

See the label attached on the back of the set and quote this information to your dealer when you require service.

Table of Contents

Important Safety instructions	3
First step	
Safety instructions	5
LCD TV Overview	
Front and side view	11
Connection Panel Overview	11
Remote Control Key Functions	12
Using the remote control	13
Accessories	14
Equipment Connections and Setup	
VCR Setup	15
Cable Box Setup	16
DTV Setup	17
DVD Setup	18
PC Setup	18
DVI Setup	19
Basic Features Setup and Operation	
Turning on the TV	21
Checking features	21
Sleep Timer	
Setting Sleep Timer	22
Picture & Sound	
Adjusting picture control	23
Adjusting picture appearance	23
Auto Sound Control	24
Adjusting Sound: Balance	24
Setting up TV stations	
Auto programme tuning	25
Manual programme tuning	25
Special Features	
Selecting language for the menus	27
Selecting COLOUR TEMP. for the menus	27
Selecting CLOSED CAPTION for the menus	28
Selecting PARENTAL CONTROL for the menus	28
Selecting 3D COMB FILTER for the menus	31
Selecting PC CONTROL for the menus	32
Selecting CLOCK for the menus	32
Setting picture format	34
Picture In Picture(PIP) function	34
Twin picture function	35
Multi PIP	36
Others	
Troubleshooting check list	37
Product specifications	38
Maintenance Guide	39

Important Safety Instruction

- 1) Read all of these instructions.
- 2) Save these instructions for later use.
- 3) Follow all warnings and instructions marked on the product.
- 4) Follow all instructions.
- 5) Do not use the TV near water.
- 6) Clean only with dry cloth.
- 7) Do not block any ventilation openings. Install in accordance with the manufacturer's instructions.
- 8) Do not install near any heat sources such as radiators, heat registers, stoves, or other apparatus (including amplifiers) that produce heat.
- 9) Do not defeat the safety purpose of the polarized or grounding-type plug. A polarized plug has two blades with one wider than the other. A grounding type plug has two blades and a third grounding prong. The wide blade or the third prong are provided for your safety. If the provided plug does not fit into your outlet. Consult an electrician for replacement of the obsolete outlet.
- 10) Protect the power cord from being walked on or pinched particularly at plugs, convenience receptacles, and the point where they exit from the apparatus.
- 11) Only use attachments/accessories specified by the manufacturer.
- 12) Do not place the TV on an unstable cart, stand or table. The TV may fall, causing serious damage to the TV.
- 13) Unplug this apparatus during lightning storms or when unused for long periods of time.
- 14) Refer all servicing to qualified service personnel. Servicing is required when the apparatus has been damaged in any way, such as power-supply cord or plug is damaged, liquid has been moisture, does not operate normally, or has been dropped.
- 15) The apparatus shall not be exposed to dripping or splashing and that no objects filled with liquids, such as vases, shall be placed on the apparatus.



Shock Hazard Marking and Associated Graphical Symbols



Explanation of Safety Related Symbols

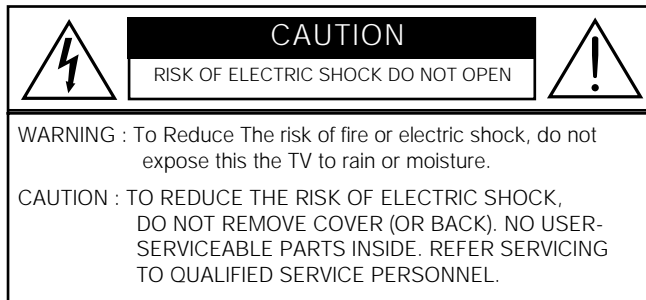

|| This symbol is intended to alert the user to the presence of uninsulated "dangerous voltage" within the product's enclosure that may be of sufficient magnitude to constitute a risk of electric shock to persons.



|| This symbol is intended to alert the user to the presence of important operating and maintenance(servicing) instructions in the literature accompanying the appliance.

WARNING : To Reduce The risk of fire or electric shock, do not expose this the TV to rain or moisture.

Important Safety Instruction

FCC INFORMATION (U.S.A.)

Note: This equipment has been tested and found to comply with the limits for a Class B digital device, pursuant to part 15 of the FCC Rules. These limits are designed to provide reasonable protection against harmful interference in a residential installation. This equipment generates, uses and can radiate radio frequency energy and, if not installed and used in accordance with the instructions, may cause harmful interference to radio communications. However, there is no guarantee that interference will not occur in a particular installation. If this equipment does cause harmful interference to radio or television reception, which can be determined by turning the equipment off and on, the user is encouraged to try to correct the interference by one or more of the following measures:

- Reorient or relocate the receiving antenna.
- Increase the separation between the equipment and receiver.
- Connect the equipment into an outlet on a circuit different from that to which the receiver is connected.
- Consult the dealer or an experienced radio/TV technician for help.

This device complies with part 15 of the FCC Rules. Operation is subject to the following two conditions: (1) This device may not cause harmful interference, and (2) this device must accept any interference received, including interference that may cause undesired operation.

Safety Instructions

Indoor Installation

⚠ WARNING

Do not place the TV in direct sunlight or near heat sources such as radiators, fires and stove etc.
 • This may cause a fire hazard !



⚠ NOTES

Do not place inflammable materials beside the TV
 • This may cause a fire hazard !

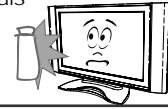

⚠ NOTES

When unpacking or moving the TV two people will be necessary to lift it safely.

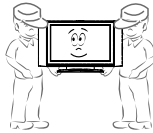

Do not place the TV where it might be exposed to dust.
 • This may cause a fire hazard !



⚠ NOTES

Ensure good ventilation around the TV. The distance between the TV and the wall should be more than 10cm.
 • It makes internal temperature increase and causes a fire.

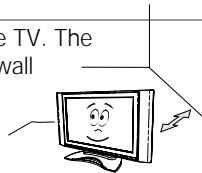

Do not cover the ventilation of the TV.
 • This may cause a fire hazard !



* Safety instructions have two kinds of information as illustrated below.

⚠ WARNING

The violation of this instruction may cause serious injuries and even death.

⚠ NOTES

The violation of this instruction may cause light injuries or damage of the product.
 • Take care of danger that may happen under specific condition.

⚠ NOTES

Disconnect from the main and remove all connections before moving.



Do not place the TV close to sources of steam or oil such as a humidifier.
 • This may cause a fire hazard or an electric shock hazard !



⚠ NOTES

When installing the monitor on a table, be careful not to place it near the edge.
 • This may cause the monitor to fall causing serious injury to a child or adult and serious damage to the monitor.
 • Surely use a fitting table or rack.



Only use the TV on a level and stable surface.
 • It may fall down or be upset.



⚠ NOTES

Do not place the TV directly on a carpet, rug or place where ventilation is restricted.
 • This would cause its internal temperature to increase and might cause a fire hazard !



Safety Instructions

Outdoor Installation

⚠ WARNING

Do not use the TV in a damp place such as a bathroom where it is likely to get wet.

- This may cause a fire or an electric shock hazard !

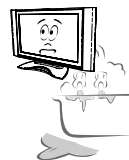

⚠ WARNING

In case of using a receiver (VCR, Digital Set Top Box), do not place an antenna in the vicinity of power lines.

- This may cause an electric shock.



In case of using a receiver (VCR, Digital Set Top Box), contact your service center to construct an antenna because it needs a skilled man.

- This may cause an electric shock.

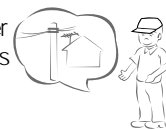

Power

⚠ WARNING

Earth wire should be connected.

- If the earth wire is not connected, there is possible a danger of electric shock caused by the current leakage.
- If grounding methods are not possible, a separate circuit breaker should be employed and installed by a qualified electrician.
- Do not connect ground to telephone wires, lightning rods or gas pipe.

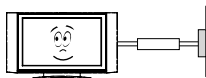

The main plug should be inserted fully into the power outlet to avoid a fire hazard !

- This may cause a fire hazard !



⚠ NOTES

In case of using a receiver (VCR, Digital Set Top Box), Bend antenna cable between inside and outside building to prevent rain from flowing in.

- This may cause water damaged inside the TV and could give an electric shock.

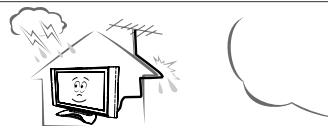

⚠ NOTES

In case of using a receiver (VCR, Digital Set Top Box), there should be enough distance between an outside antenna and power lines to keep the former from touching the latter even when the antenna falls.



- This may cause an electric shock hazard.



Safety Instructions

Power

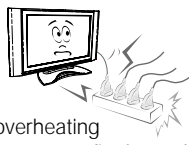
⚠ NOTES

<p>Do not place heavy objects on the power cord</p> <ul style="list-style-type: none">• This may cause a fire or an electric shock hazard ! 	<p>Do not use too many plugs on the main multi-outlet.</p> <ul style="list-style-type: none">• It may result in overheating of the outlet and causes a fire hazard ! 	<p>Never touch the power plug with a wet hand</p> <ul style="list-style-type: none">• This may cause an electric shock hazard ! 
---	--	---

⚠ NOTES

<p>Hold the plug firmly when unplugging. If you pull the cord the cord may be damaged.</p> <ul style="list-style-type: none">• This may cause a fire hazard !	<p>Prevent dust collecting on the power plug pins or outlet.</p> <ul style="list-style-type: none">• This may cause a fire hazard !
---	---

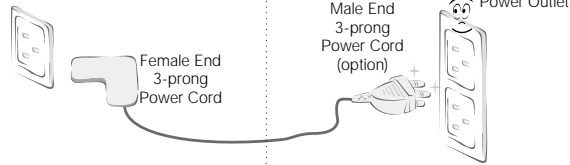

Using

⚠ WARNING

Do not place anything containing liquid on top of the TV such as flowerpot, cup, cosmetics or candle.



- This may cause a fire hazard !



⚠ WARNING

<p>If water is spilled into the monitor unplug it from the main supply outlet immediately and consult your Service Agent.</p> <ul style="list-style-type: none">• This may cause an electric shock hazard ! 	<p>Dispose of used batteries carefully and safely.</p> <ul style="list-style-type: none">• In the case of a battery being swallowed by a child please consult a doctor immediately. 
---	---

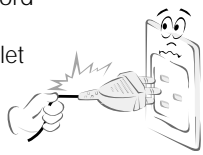
⚠ NOTES

<p>Do not plug in when the power cord or the plug is damaged or the connecting part of the power outlet is loose.</p> <ul style="list-style-type: none">• This may cause a fire or an electric shock hazard ! 	<p>Ensure the power cord does not come into contact with sharp or hot objects such as a heater.</p> <ul style="list-style-type: none">• This may cause a fire or an electric shock hazard ! 
---	---

Safety Instructions

Using

⚠ NOTES

In case of impact shock or damage to the monitor switch it off and unplug it from the outlet and contact your service center.

- This may cause a fire or an electric shock hazard !

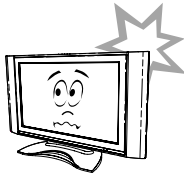

Do not allow any objects to fall into the TV.

- This may cause an electric shock hazard !

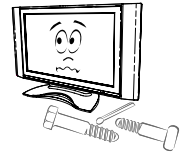

⚠ NOTES

Do not drop the TV or allow impact shock.

- This may cause mechanical failure or injury !

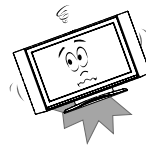

⚠ WARNING

In the event that an image does not appear on the screen please switch it off and unplug it from the main supply and contact your Service Centre.

- This may cause a fire or an electric shock hazard !

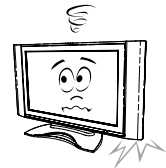

Cleaning

⚠ WARNING

Do not use water while cleaning the TV

- This may damage to the TV or an electric shock hazard.



In the unlikely event of smoke or a strange smell from the TV, switch it off ,unplug it from the wall outlet and contact your dealer or service centre.

- This may cause a fire or an electric shock hazard !



Others

⚠ WARNING

Do not attempt to service the TV yourself. Contact your dealer or service center.

- This may cause damage to the TV and could give an electric shock as well as invalidating the warranty !



In the event of a lightning or thunder storm unplug the TV and aerial from the wall outlet.



- This will prevent damage to the monitor and possible electric shock.



Safety Instructions

Others

<p>⚠ WARNING</p> <p>Do not watch the TV while driving or walking.</p> <ul style="list-style-type: none">• This may cause an accident. 	<p>⚠ NOTES</p> <p>Do not place heavy objects on the TV.</p> <ul style="list-style-type: none">• This may cause serious injury to a child or adult. 
--	---

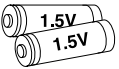
<p>⚠ NOTES</p> <p>The distance between eyes and the screen should be about 1.5m.</p> <ul style="list-style-type: none">• If not, eyes will strain. 	<p>Unplug the TV from the wall outlet when it is left unattended and unused for long periods of time.</p> <ul style="list-style-type: none">• Accumulated dust may cause a fire or an electric shock from deterioration or electric leakage. 	<p>Only use the specified batteries.</p> <ul style="list-style-type: none">• This may cause damaged the TV or could give an electric shock.  <p>AAA x 2</p>
---	--	--

***FRONT AND SIDE VIEW**

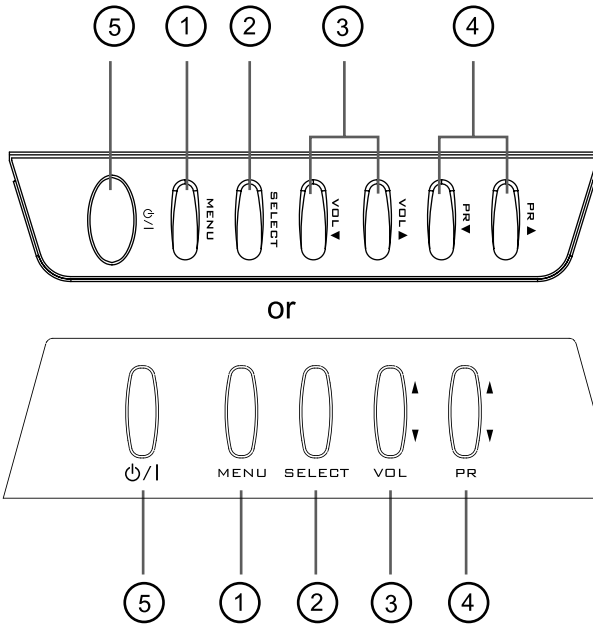

1. POWER button : Switches TV set on or off.
2. MENU button : Displays a menu.
3. SELECT button : Selects the A/V source.
4. VOLUME (▲ / ▼) : Adjusts the volume / Adjusts menu settings.
5. PR (▲ / ▼) : Selects a programme or menu item.

***Connection Panel Overview**

Back Panel

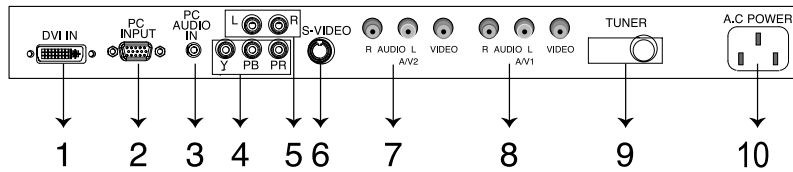

1. DVI IN : Digital Video Interface.
2. RGB-DTV / PC INPUT : PC OR DTV Video Source Input.
3. PC AUDIO IN : Connect the audio cable from the PC to the PC AUDIO IN of the set.
4. L, R : Audio(L / R) Input in case of S-VIDEO or COMPONENT mode.
5. Y, Pb, Pr : Component video signal input.
6. S-VIDEO : S-VIDEO signal input.
7. AV2 : Composite input.
8. AV1 : Composite input.
9. TUNER : RF ANTENNA INPUT.
10. A.C POWER : CORD INPUT.

Remote Control Key Functions

- When using the remote control aim it at the remote control sensor on the TV

1. POWER

Turns on TV or off from st/by mode.

2. MUTE

Turns the sound on and off.

3. NUMBER buttons

Selects programme numbers.

4. MENU

Displays a main menu.

5. TV/AV

Selects TV, AV1, AV2, S-VIDEO, COMPONENT, RGB-DTV, RGB-PC, RGB-DVI mode.

6. SLEEP button

Sets the sleep timer.

7. ENTER

Accepts your selection or displays the current mode.

8. VOL+/- button

Adjusts the sound level./ Adjusts the menu settings.

9. PR+/- button

Selects next programme or menu items.

10. APC button

Recalls your preferred picture settings.

11. ASC button

Recalls your preferred sound settings.

12. ARC button

Selects a screen mode- 16:9, 14:9, ZOOM, PANORAMA

13. REVIEW button

Returns to the previously viewed programme.

14. PIP button

Displays a PIP(Picture In Picture) screen.

15. MULTI PIP button

Displays a still picture of TV signal on main screen.

16. MULTI MEDI button

Selects component, RGB-DTV, RGB-PC, RGB-DVI.

17. MTS button

Selects the language during dual language broadcast, selects the sound output.

18. PIP CH+/-

Selects a programme when RF signal is displayed in PIP mode.

19. SWAP

Switches a main picture for sub picture in PIP mode.

20. INPUT

Selects the AV source of sub picture in PIP mode.

21. SIZE

Selects the size of sub picture(Double Window or Small Window).

22. POSITION

Selects a position of PIP screen.

23. STILL

In case of non PIP mode, Displays the still main picture.

In case of PIP mode, Displays the still sub picture.

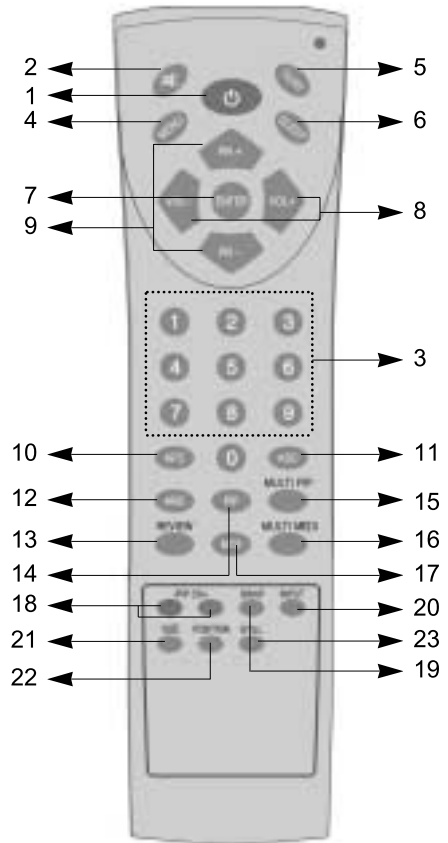

Remote Control Key Functions

TV/AV select button on the remote control
Each press of this button changes the mode as shown below

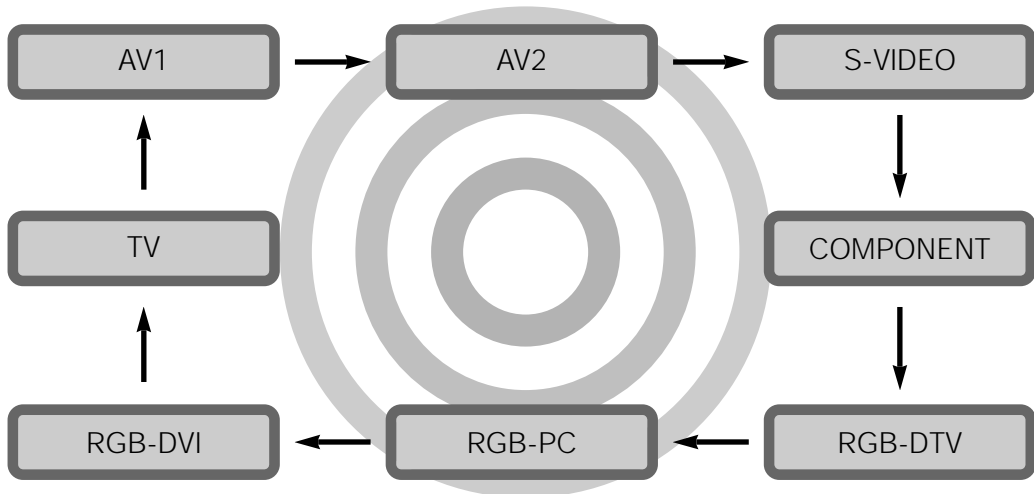

MULTI MEDI select button on the remote control
Each press of this button changes the mode as follows.

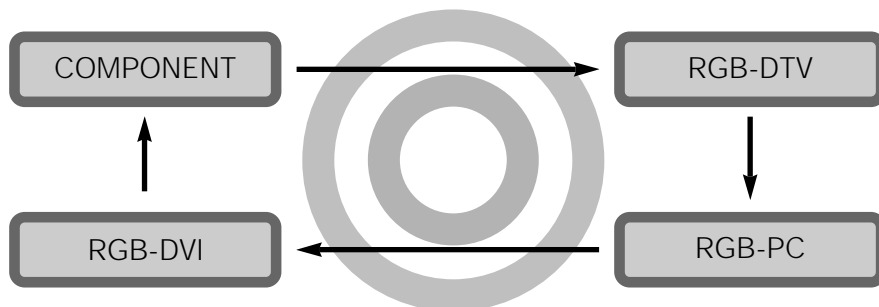

Using the remote control

Installing batteries



- Open the battery compartment cover on the back of the remote control and insert the batteries with correct polarity, match "+" with "+", and match "-" with "-".
- Install two 1.5V "AAA" alkaline batteries.
Don't mix used batteries with new batteries.

Using the remote control

Notes for using the remote control

Make sure there are no objects between the remote control and its sensor.

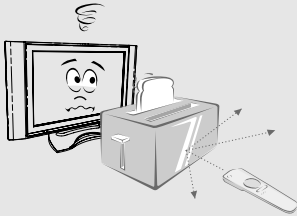

Don't place the remote control near a heater or damp place. Strong impact on the remote control may cause operation failure.

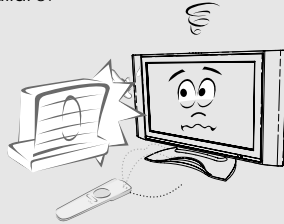

Signal from the remote control may be disturbed by sun light or other strong light. In this case, turn the set to other direction.

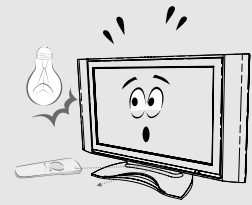

Accessories

Accessories



Remote control



Owner's Manual



Power cord

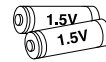

Alkaline batteries

Speaker

Option

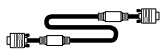

D-sub 15 pin cable



HDMI cable



S-VIDEO cable



Component cable



AUDIO cable



PC sound cable



Wall Mount Bracket



Universal Remote Control

VCR Setup

- Connect an antenna or a RCA Cable between the ANTENNA jack on the rear of the TV and the ANTENNA OUT jack on the VCR.
- Connect the RCA Jack of the VCR to the RCA AV1 or AV2 of the set.
- Press the PLAY button on the VCR.
- When connecting the S-VIDEO VCR to the S-VIDEO socket, the picture quality will be further improved.
- Connect the S-VIDEO socket of the VCR to the S-VIDEO socket of the set.
- Connect the audio cable from the S-VIDEO VCR to the AUDIO sockets of the set.
- Select the S-VIDEO by pressing the TV/AV button repeatedly.
- Press the PLAY button on the VCR. The VCR playback picture appears on the screen

Connection of external equipment

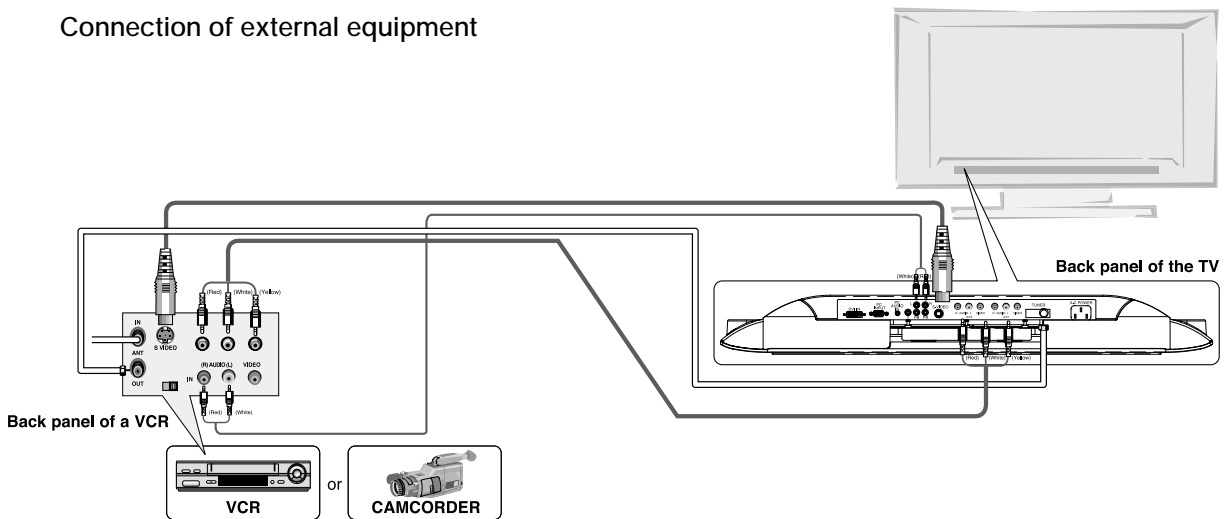

Tips

- To avoid picture noise (interference), leave an adequate distance (20 inches or more) between the VCR and TV.

To watch VCR

1

Press TV/AV button on the remote control and select AV1 or AV2. (When connecting with the S-Video, select the S-VIDEO.)

2

Insert a video tape into the VCR and press the PLAY button on the VCR. See VCR owner's manual.

Cable Box Setup

- After subscribing to cable TV service from a local provider and installing a converter, you can watch cable TV programs.

Connection of external equipment

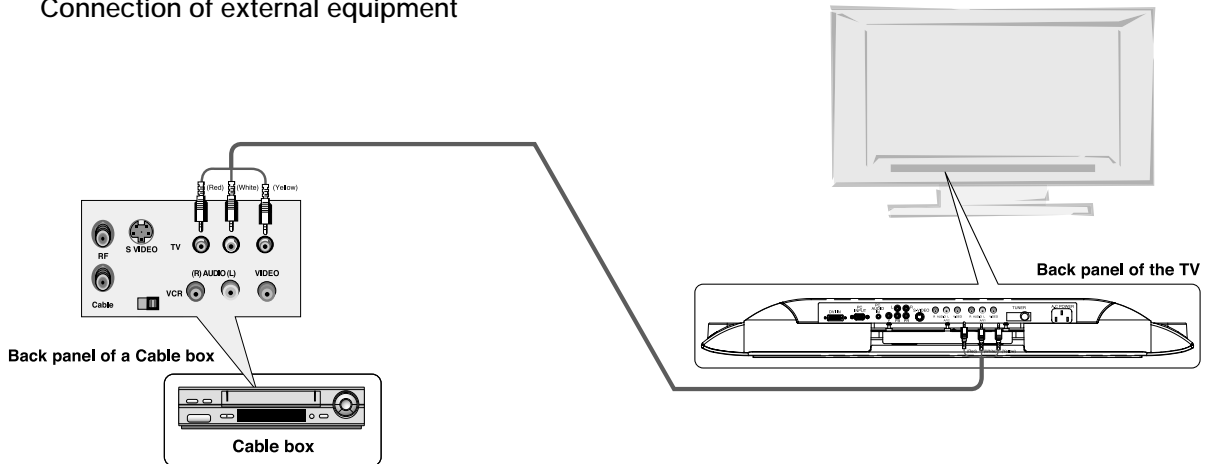

Tips

- For further information regarding cable TV service, contact your local cable TV service provider(s).

To watch Cable TV

1

Press TV/AV button on the remote control and select VIDEO source.

2

Tune to cable service provided channels using the cable box.

DTV Setup(SET-TOP BOX)

- To watch digital broadcast programs, purchase/connect a digital SET-TOP BOX.

How to connect a DTV

- You can use either the Monitors COMPONENT (DVD/DTV/INPUT) inputs or the single RGB-DTV/PC INPUT for video connections, depending on your Set Top Box connectors. Then, make the corresponding Audio connections.
- DTV input is available to 480i/p, 720p, 1080i mode.

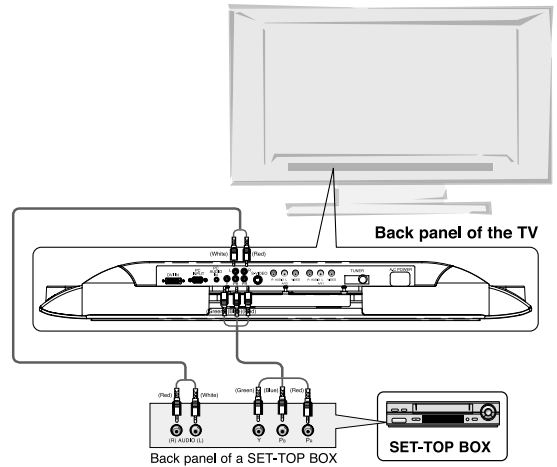

Connection of external equipment

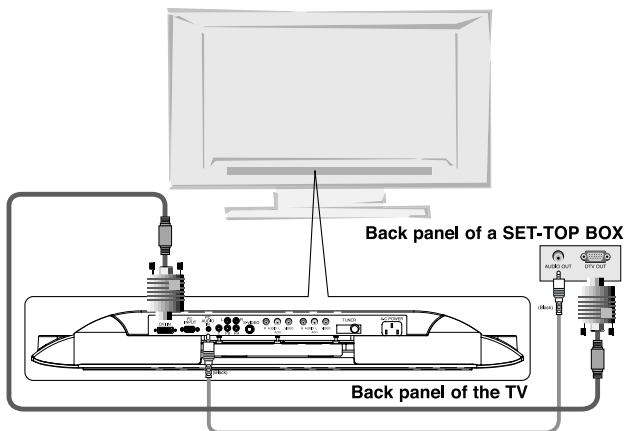

To watch SET-TOP BOX

1

Press TV/AV button on the remote control to select COMPONENT or RGB DTV.

2

Tune to the digital SET-TOP BOX.
(Refer to the owner's manual for the digital SET-TOP BOX.)

DVD Setup

How to connect a DVD (digital video disk player)

- Connect DVD video inputs to Y, Pb, Pr of COMPONENT (DVD/DTV INPUT) and audio inputs to Audio jacks of AV INPUT.
- Component Input is available to 480i/p, 720p, 1080i mode.

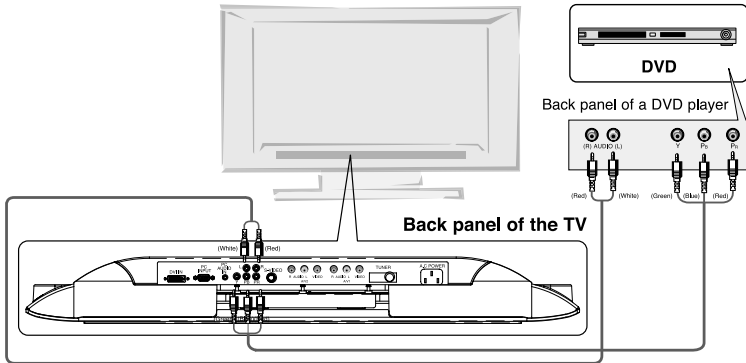

How to use

- Press TV/AV button on the remote control of the TV to select COMPONENT. Use the DVD player according to its owner's manual.
- Turn on the DVD player, and insert a DVD.
- Component Input ports
Connect DVD player jacks to TV Component input jacks as indicated below.

Component input jacks on the TV	Y	PB	PR
Video output jacks of DVD player	Y	Pb	Pr
	Y	B-Y	R-Y
	Y	Cb	Cr
	Y	PB	PR

PC Setup

- You can easily connect the Display to your PC for outstanding image and sound.

Setup Instructions to Connect a PC to your TV

- To setup this TV in your PC window environment, select Normal, Standard or Default TV. This TV does not support Plug and Play function
- The screen does not display when the resolution is over UXGA.
- Connect the signal cable from the TV Output port on the PC to the RGB, DV1 (PC/DTV INPUT) port on the TV.
- Connect the audio cable from the PC to the Audio ports of the TV.
- If your PC computer is equipped with a sound card, adjust the sound output on the PC.
- Select the display resolution of the PC to 1366X768 for the best picture. This TV resolution is 1366X768.

PC Setup

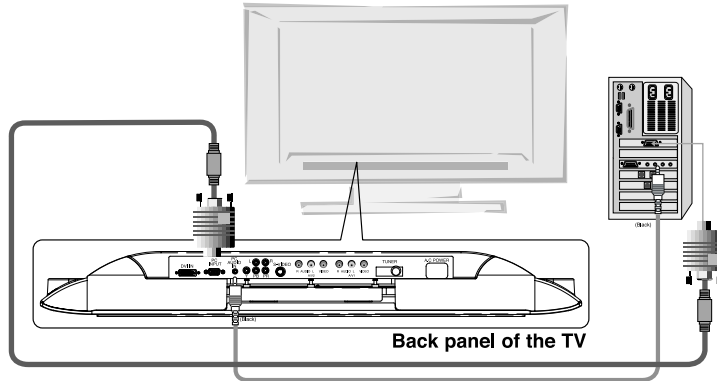

PC Setup

- First, turn on the PC computer and press the ON/OFF button on the TV to apply power to it. Second, turn on the display by pressing the button on the TV or by pressing the POWER button on the TV remote control.
- Use the TV/AV button on the remote control to select the RGB-PC input source.
- Set the resolution output of the PC to WXGA or under (1366X768, 60Hz).

Tips

- Avoid keeping a fixed image on the TV screen for a long period of time. The fixed image may become permanently imprinted on the screen; use a screen saver when possible.
- Change the resolution of PC to displayable mode and connect to RGB1 Input (PC/DTV Input) jacks of the TV.

DVI Setup[Option]

- You can easily connect the Display to your PC for outstanding image and sound.

Setup Instructions to Connect a PC to your TV

- To setup this TV in your PC window environment, select Normal, Standard or Default TV. This TV does not support Plug and Play function
- The screen does not display when the resolution is over UXGA.
- Connect the signal cable from the monitor Output port on the PC to the DVI-JN port on the Monitor.
- Connect the audio cable from the PC to the Audio ports of the TV.
- If your PC computer is equipped with a sound card, adjust the sound output on the PC.
- Select the display resolution of the PC to 1366X768 for the best picture. This TV resolution is 1366X768.

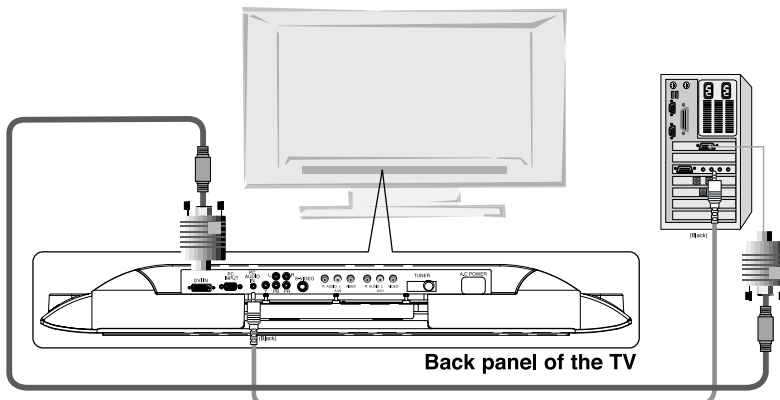

DVI Setup[Option]

PC Setup

- First, turn on the PC computer and press the ON/OFF button on the TV to apply power to it. Second, turn on the display by pressing the button on the TV or by pressing the POWER button on the TV remote control.
- Use the TV/AV button on the remote control to select the RGB-PC input source.
- Set the resolution output of the PC to WXGA or under (1366X768, 60Hz)

Tips

- Avoid keeping a fixed image on the TV screen for a long period of time. The fixed image may become permanently imprinted on the screen; use a screen saver when possible.
- Change the resolution of PC to displayable mode and connect to DVI-D Input jacks of the TV.

TV Image Display Specifications (RGB-PC, RGB-DVI)

Resolution	Vertical Frequency (Hz)	Resolution	Vertical Frequency (Hz)
720*400	70	1024*768	60
	85		70
640*480	60		1280*768
	67	60	
	72	832*624	75
	75		
	85		
800*600	56		
	60		
	72		
	75		

Tips

- Synchronization input form : separate
- Dos mode may not work depending on a video card if using a DVI cable.

Turning on the TV

- When using the remote control, aim it at the sensor on the TV.

Turning on the TV just after installation

1

Connect power cord correctly. At this moment, the TV is switched to Standby mode.

2

Press the POWER button on the TV or press the POWER Button or associated with TV button on the remote control and then the TV will be turn on.

Turning on the TV (power cord is still connected)

1

If the TV is turned off with the remote control button or POWER ON/OFF button on the TV. Press the POWER button on the TV or press the POWER button on the remote control and then the TV will be turn on.

Tips

- Adjusting volume level
The volume(+) button increases the sound and the volume(-) button reduces the level of sound.

Checking features

- Use the remote control to make adjustments.
- Select VIDEO input source.

1

Press the MENU button.

2

Press the VOL+/- button.

- Each press will cycle through the menus shown below.

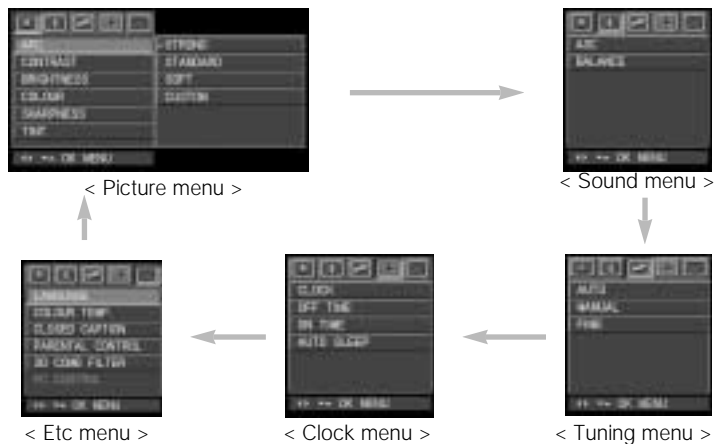

Checking features

3

Press the PR+/- button.

4

Press the VOL (+) button to select a feature to adjust, and then press the PR+/- buttons to adjust the selected item.

- Press the MENU button to exit.

Setting Sleep Timer

Sleep Timer turns the TV off after a preset time

Press the SLEEP button to set sleep time.

Each time you press SLEEP button, the next preset setting time is changed as follows:

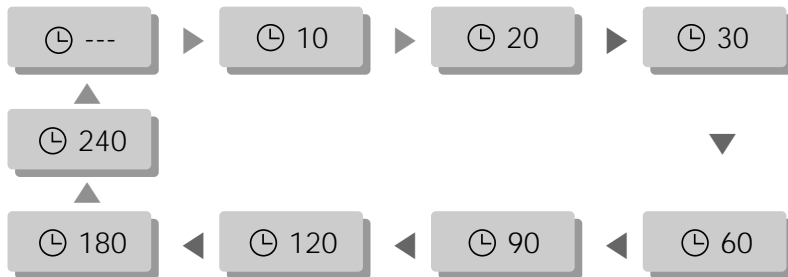

- To release sleep time setting, press the SLEEP button repeatedly to select ---.

Tips

- To check remaining sleep time after setting, press the SLEEP button just once.
- If you turn the TV off after setting the sleep timer, the setting is erased. The sleep timer will then have to be set again.

Adjusting picture control

Use APC to set the TV for the best picture appearance

APC (Auto Picture Control)

1

Press the APC button.

2

Press the APC buttons to select your desired picture condition.



- Each press of APC button changes the screen display as shown below.



- You can also select STANDARD, SOFT, CUSTOM or STRONG in the PICTURE menu.

Adjusting picture appearance

Press the MENU button and then press the VOL +/- button to select PICTURE menu. Press the PR - button.

1

Press the PR +/- button to select Contrast and then press the VOL + button.



2

Use the VOL buttons to make appropriate adjustments and then press the ENTER button.

- Press the PR +/- buttons to select other items.



- Adjust BRIGHTNESS, COLOUR and SHARPNESS, TINT in the same way.

Auto Sound Control

ASC(Auto Sound Control)

1 Press the MENU button and then VOL+/- button to select a SOUND setup.

2 Press PR- button and then VOL+ button to select a sound setup.



• Each press of ASC or PR+/- button changes the screen display as shown below.

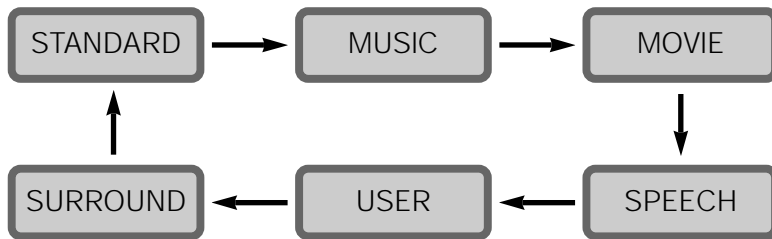

• You can also select SURROUND, STANDARD, MUSIC, SPEECH, MOVIE, USER in the SOUND menu.

Adjusting Sound: Balance

Manual Settings

Press the MENU button and then press the VOL+/- button to select SOUND menu.
Press the PR- button.

1 Press the PR- button to select BALANCE and then press the VOL(+) button.



2 Use the VOL(+/-) buttons to make appropriate adjustments and then press the ENTER button.

Auto programme tuning

Up to 125 TV stations can be stored by programme numbers (1 to 125).
Once you have preset the stations, you will be able to use the PR+/PR- or NUMBER buttons to scan the stations you programmed.
Stations can be tuned using automatic or manual modes.

Note : In some models up to 181 CH stations can be stored.

All stations that can be received are stored by this method. It is recommended That you use auto programme during installation of this set.

1

Repeatedly press the MENU button and then press VOL+/- button to select the TUNING menu.

2

Press the PR - button to select AUTO.



3

Press the VOL+ button to begin auto programming.

MANUAL programme tuning

Manual programme lets you manually tune and arrange the stations in whatever order you desire. Also you can assign a station name with five characters to Each programme number.

1

Repeatedly press the MENU button to select the Station menu.

2

Press the PR - button to select MANUAL.



3

Press the VOL+ button to display the MANUAL programme menu.

MANUAL programme tuning

4

Press the PR+/- button to select the programme number.



5

Press the VOL+ button to select the ADD and ERASE.
Select the desired programme number (1 to 125) with the PR+/- button.



6

Press the ENTER button.

7

Press the PR+/- button to select FINE.



Press the VOL+ button.

Press the VOL+ button to fine tune for the best picture and sound on the Fine pull-down menu.



Press the VOL+ button.

Selecting language for the menus

Press the MENU button and then press the VOL+/- button to select ETC menu.
Press the PR - button.

1

Press the PR+/- button to select Language and then press the VOL (+) button.



2

Press the PR+/- button to select the desired language.



3

Press the ENTER button.

Selecting COLOUR TEMP. for the menus

Press the MENU button and then press the VOL+/- button to select ETC menu.
Press the PR- button.

1

Press the PR+/- button to select COLOUR TEMP and then press the VOL (+) button.



1

Press the PR+/- button to select the desired COLOUR TEMP.



3

Press the ENTER button.

Selecting CLOSED CAPTION for the menus

Press the MENU button and then press the VOL+/- button to select ETC menu.
Press the PR- button.

1

Press the PR+/- button to select CLOSED CAPTION and then press the VOL (+) button.



2

Press the VOL+/- button to select the desired CLOSED CAPTION.
Each press of this button changes the mode as follows.

CC1 → CC2 → CC3 → CC4 → TEXT1 → TEXT2 → TEXT3 → TEXT4 → OFF



3

Press the ENTER button.

Selecting PARENTAL CONTROL for the menus

Press the MENU button and then press the VOL+/- button to select ETC menu.

1

Press the PR+/- button to select PARENTAL CONTROL and then press the VOL+ button.



Press the PR+/- button to select PARENTAL CONTROL and then enter your current password using the number on the remote control.

2

Press the VOL + button and then VOL+/- button to select the desired OFF/ON and then press the ENTER button.



Selecting PARENTAL CONTROL for the menus

3

Press the PR+/- button to select SET PASSWORD and then press the VOL+ button.



Enter your current password using the number buttons on the remote control. (The default password is 0000)
Re enter the password to confirm.
your new password is active.
Press the ENTER button.

4

Press the PR+/- button to select MPAA and then press the VOL+ button.
Press the VOL+/- button to select the desired ratings.



Press the ENTER button.

5

Press the PR+/- button to select AGE BLOCK and then press the VOL+ button.



Press the PR+/- button to select GENERAL.
Press the VOL+ button to select the desired ratings.
Press the PR+/- button to select other items.
Press the ENTER button and then press the VOL button.

6

Press the PR+/- button to select CONTENT BLOCK and then press the VOL+ button.



Press the VOL+ button and then VOL+/- button to select the desired rating.
Press the ENTER button.
Press the PR+/- button to select other items.
Select the desired rating LANGUAGE,SEX SCENE,VIOLENCE,
F VIOLECE and NORATING in the same way.
Press the VOL+ button.

Selecting PARENTAL CONTROL for the menus

3

Press the PR+ button and then PR+/- button to select AUX CONTROL and then press the VOL+ button.
Press the VOL+/- button to select the desired rating.



Press the ENTER button.

TV Guidelines

- TV-MA** Mature audiences only. This program may contain mature themes, profane language, graphic violence and explicit sexual content.
- TV-14** Parents strongly cautioned. This program may contain sophisticated themes, sexual content, strong language and more intense violence.
- TV-PG** Parental guidance suggested. This program may contain infrequent coarse language, limited violence, some suggestive sexual dialogue and situations.
- TV-G** General audience. It contains little or no violence, no strong language, and little or no sexual dialogue or situations.
- TV-Y7** Directed to older children. Themes and elements in this program may include mild physical or comedic violence, or may frighten children under the age of seven.
- TV-Y** All children. The themes and elements in this program are specifically designed for a very young audience, including children from ages two-

MPAA Ratings

- G** General audience. No restriction.
- PG** Children under 13 should be accompanied by an adult.
- PG-13** Parental guidance suggested.
Children under 13 should be accompanied by an adult.
- R** Restricted. Viewers should be 17 or older.
- NC-17** Not classified. Viewers should be 17 or older.
- X** Adults only.
- NR** Not rated.

Selecting 3D COMB FILTER for the menus

Press the MENU button and then press the VOL+/- button to select ETC menu.
Press the PR - button.

1

Press the PR+/- button to select 3D COMB FILTER.



2

Press the VOL+ button to select OFF.



3

Press the VOL+ button to change the state of ON or OFF.



4

Press the ENTER button.

- ON/OFF state of 3D COMB FILTER is user choice.
- It is better to select the 3D COMB FILTER "OFF", when TV Broadcast is sports, action movie.

Selecting PC CONTROL for the menus

Press the MENU button and then press the VOL+/- button to select ETC menu.
Press the PR- button.

1

Press the PR+/- button to select PC CONTROL and then press the VOL (+) button.



2

Use the VOL +/- button to make appropriate adjustments and then Press the ENTER button.



3

Press the PR+/- button to select other items.

The OSD function for this PC control becomes activated, when the sources are available on RGBDTV/ PC INPUT or DVI-IN external connector.

Selecting CLOCK for the menus

Press the MENU button and then press the VOL+/- button to select CLOCK menu.
Press the PR- button.

1

Press the PR+/- button to select CLOCK and then press the VOL(+)button.
Press the PR+/- button select time.
Press the ENTER button.



2

Press the PR+/- button to select OFF TIME and then press the VOL(+) button.
Press the PR+/- button select time and ON/OFF.
Press the ENTER button.



Selecting CLOCK for the menus

3

Press the PR+/- button to select ON TIME and then press the VOL(+) button.
Press the PR+/- button to select time and PR, VOL, ON/OFF.
Press the ENTER button.



4

Press the PR+/- button to select AUTO SLEEP and then press the VOL(+) button.
Press the PR+/- button to select ON/OFF.
Press the ENTER button.



Setting picture format

Press the ARC button to select a desired picture format.

- Each time you press ARC button, you can select 16:9 or 4:3 or ZOOM or PANORAMA alternatively.

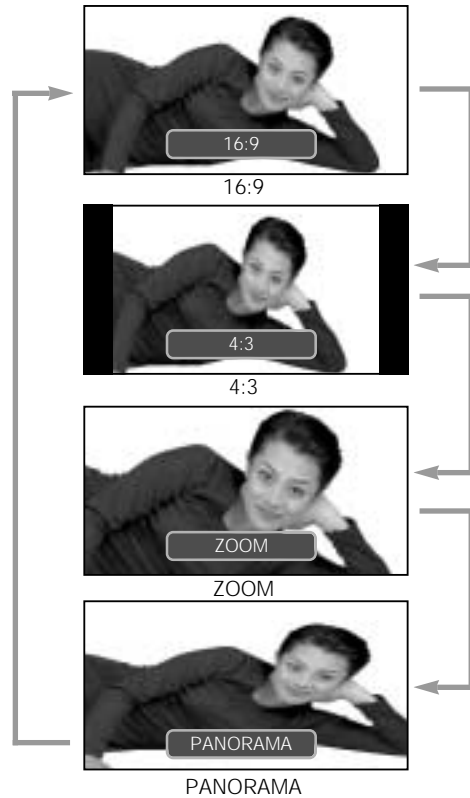

Picture in picture (PIP) function

- PIP PICTURE will let you view two separate inputs on your TV screen at the same time.
- Color of main picture may be different from PIP's in PIP PICTURE.
- When the main picture is TV/AV1/AV2/S-VIDEO/COMPONENT/RGB-DTV/RGB-PC/ RGB-DVI, the sub picture is input / TV/AV1/AV2/S-VIDEO.

How to use the PIP

Press the PIP button.



- If you press the PIP button again, the function is off.

Moving the sub picture

Press the POSITION button in PIP.

- Each time you press the POSITION button, sub picture Position is changed as follows.

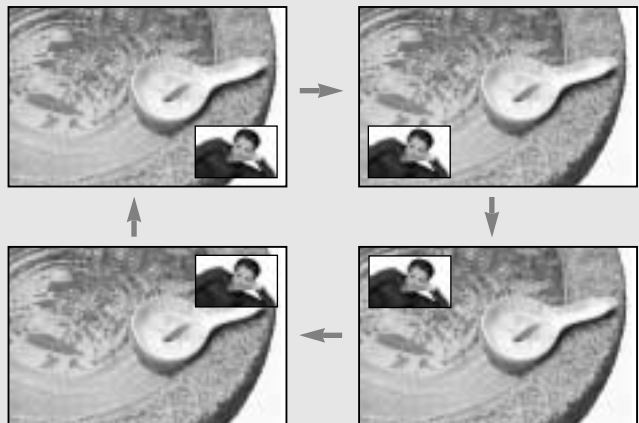

Picture in picture (PIP) function

Change the main picture and the sub picture

Press the SWAP button in PIP mode.

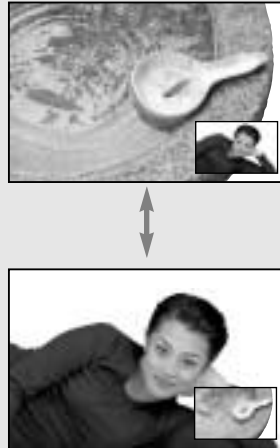

When the main picture is TV/AV1/AV2/S-VIDEO, the sub picture input is TV / AV1 /AV2 / S-VIDEO.

Twin picture function

How to use twin picture

Press the SIZE button to select twin picture.

Each time you press SIZE button, you can select TWIN or PIP alternatively.

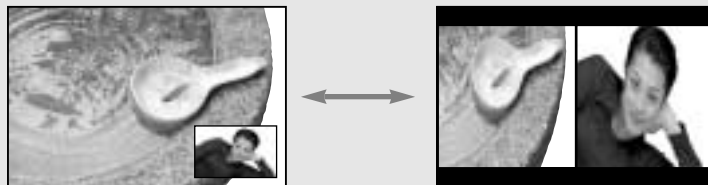

- TWIN PICTURE let you view different inputs on your TV screen at the same time.
 - Color of main picture may be different from PIP's in PIP/TWINPICTURE.
 - When the main picture is TV / AV1 / AV2 / SVIDEO / the sub picture input is TV / AV1 / AV2 /S-VIDEO.

Input select of the sub picture

Press the BLUE color button to select the input of sub picture.



Twin picture function

Changing the picture of main and sub picture

- PIP/TWIN PICTURE let you view different inputs on your TV screen at the same time.
- Color of main picture may be different from PIP's in PIP/TWIN

PICTURE. Press the SWAP button in twin picture mode.

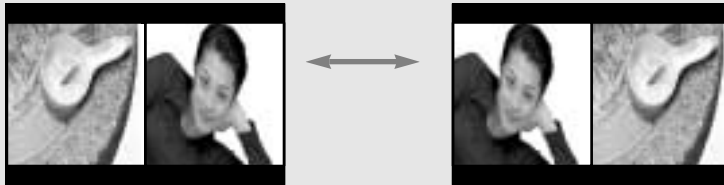

- When the main picture input is TV / AV1 / AV2 / S-VIDEO/, the sub picture input is TV/AV1/AV2/S-VIDEO.

MULTI PIP

This function can be operated when input signal is TV signal.

When pressing MULTI PIP button, a still picture of TV signal is displayed on main screen and each still picture of live signal searched from TV signal is displayed on sub screen.

In case of sub screens, after shortly showing a video of live signal searched from TV signal and displaying the still picture from first sub screen, it is moving to other sub screen consequently and displays the still picture of live signal in the same way.



Troubleshooting Check list

Problem	Check item
No picture on screen and no sound from speakers.	<ul style="list-style-type: none"> • Insert the AC power cord plug securely in AC power outlet. • Make sure the remote control is not in the standby mode (The POWER/Standby indicator is red.) • Turn on the MAIN POWER button on the top of the display.
No picture/No picture from AV terminal.	<ul style="list-style-type: none"> • Check the brightness setting of the display. • Lamp may have malfunction. • Make sure a cable with no VIDEO input signal is connected to the S-VIDEO INPUT terminal.
Picture is displayed, but no sound from the speakers.	<ul style="list-style-type: none"> • Check the sound setting. • Make sure the sound is not muted. • Make sure a pair of headphones is not connected. • Make sure the connectors of the optional speaker system are securely inserted. • Make sure the setting of AV OUTPUT terminal
Picture is too light	<ul style="list-style-type: none"> • Make sure COLOUR and CONTRAST settings.
Picture is too dark.	<ul style="list-style-type: none"> • Make sure BRIGHTNESS setting is not set too low. • Check to see if BRIGHTNESS setting • Lamp may have malfunction.
Remote control does not work.	<ul style="list-style-type: none"> • Change the batteries. • Make sure the infrared transmitter window is not receiving strong light such as light from fluorescent lamps.
No picture from AV OUT terminal.	<ul style="list-style-type: none"> • Make sure AV INPUT is not set. • Make sure the input source other than AV
The picture is not sharp. The picture moves.	<ul style="list-style-type: none"> • The reception may be weak. • The state of the broadcast may also be bad. • Make sure the antenna is facing the right direction. • Make sure the outside antenna is not disconnected.
The picture is doubled or tripled.	<ul style="list-style-type: none"> • Make sure the antenna is facing the right direction. • There may be reflected electric waves from mountains or buildings.
The picture is spotted.	<ul style="list-style-type: none"> • There may be interference from automobiles, trains, high voltage lines, neon lights, etc. • There may be interference between the antenna cable and power cable. Try positioning them further apart.
There are stripes on the screen or colors fade.	<ul style="list-style-type: none"> • Is the unit receiving interference from other devices? Transmission antennas of radio broadcasting stations and transmission antennas of amateur radios and cellular phones may also cause interference. • Use the unit as far apart as possible from devices that may cause possible interference.

Product specifications

Contents	Specification		
Model Name	HLT-2672	HLT-3272	
Aspect Ratio	16:9		
Resolution	1366 X RGB X 768		
Receiving channel	VHF	Low-CH: E2 - S10	
		High-CH: E5 - S41	
	UHF	CH: E21 - E69	
Input Terminals	TV	1,0Vp-p / 75 Ω	
	VIDEO	1,0Vp-p / 75 Ω	
	S-VIDEO	Y: 1,0Vp-p / 75 Ω C: 0,3Vp-p / 75 Ω	
	COMPONENT (DVD, DTV)	Y Pb Pr (Y Cb Cr)	Y: 1,0Vp-p / 75 Ω Pb: 0,7Vp-p / 75 Ω Pr: 0,7Vp-p / 75 Ω
	DVI (Digital)	DVI-I 29 Pin (But analog input is not supported)	
	PC (Analog)	Mini D-SUB 15 Pin	
	Input Sound	Stereo RCA (S-VIDEO, Component), Stereo RCA X 2 (AV1, AV2) Stereo Jack (DVI & PC)	
	Speaker	Sound	20W(10W + 10W), 8 ohm
Power Consumption	Approx. 120W	Approx. 150W	
Dimensions	814 X 230 X 485.9 (With Stand)	950.6 X 230 X 561.8 (With Stand)	
Weight	17Kg (NET)	18,7Kg (NET)	

- The specifications shown above may be changed without prior notice for quality improvement.

Maintenance Guide

Cleaning the screen

- Always disconnect your TV from any power source when cleaning.
- Do not use substances such as glass cleaners, solvents, and thinners.
- Do not apply abrasive or ammonia-based window cleaners.
- The screen of your TV has been specially treated, and can be scratched or damaged easily. Wipe the surface gently using only a cleaning cloth or a soft, lint-free cloth.
- Do not apply water directly on the screen or any parts of the TV.
- Do not touch or scratch the surface of the screen with any hard objects.
- Do not scratch the surface of the screen with fingers.

Cleaning the exterior of TV

- Always disconnect your TV from any power source when cleaning
- Keep all vents free of dust.
- Do not drip any water into the vents.
- Do not attempt to clean dust from the inside of your TV.
- Do not use abrasive or solvent cleaners to clean your TV. This can damage the finish and components of your TV.
- Do not allow any water or moisture to come into contact with the surface of your TV. If moisture gets inside your TV, operating problems and electrical and shock hazards may result.
- Do not scratch or hit the cabinet with any objects
- Do not place objects on or near the cabinet and stands of your TV.
- Do not throw objects at the TV.

Cleaning the interior of TV

DO NOT ATTEMPT TO CLEAN THE INTERIOR OF YOUR TV. THIS WILL VOID YOUR WARRANTY, AND IS EXTREMELY DANGEROUS.

MEMO
